

e-Book

marzo vitorino



EURO

MÓVEIS
DE AÇO

EURO

MÓVEIS
DE AÇO

Selecione o tópico 

■ CORES.....	03
■ ARMÁRIOS.....	04
■ ARQUIVOS.....	10
■ LOCKERS.....	15
■ ESTANTES.....	41

Cores disponíveis

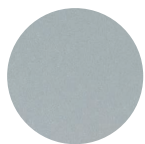

A1-CINZA ONIX



A2-CRISTAL
LISO



A3-BEGE LISO

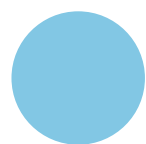

A4-AZUL CLARO



A5-PRETO



A6-LARANJA

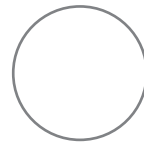

A7-BRANCO

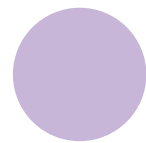

A8-LILAS



A9-VERDE



B1-VERMELHO

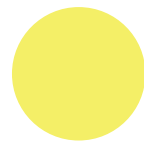

B2-AMARELO



B6-AZUL DEL REY

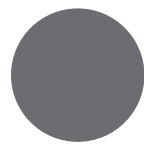

16-GRAFITE

Instruções de Cores

Lockers:

COR 1 - Corpo
COR 2 - Portas
COR 3 - Tampo

Arquivos:

COR 1 - Corpo
COR 2 - Frente de Gavetas

Armários:

COR 1 - Corpo
COR 2 - Portas

Estantes:

COR 1 - Todas as peças



Armário Aço

Sumário (selecione o item) 

Armário Aço Fechadura.....	05
Armário Aço / Modelos	05
Prateleiras para Armário Aço	07

Armário Aço Fechadura



Modelos



Armário Baixo
840A 800L 400P
Mod.: ARMB80



Armário Médio
1620A 750L 400P
Mod.: ARMM75



Armário Alto
1960A 800L 400P
Mod.: ARMA80



Armário Alto
1960A 900L 400P
Mod.: ARMA90



Armário Alto
1960A 1000L 400P
Mod.: ARMA100



Armário Alto
1960A 1100L 400P
Mod.: ARMA110



Armário Alto
1960A 1200L 400P
Mod.: ARMA120

Sistema de Fechamento

Fechadura

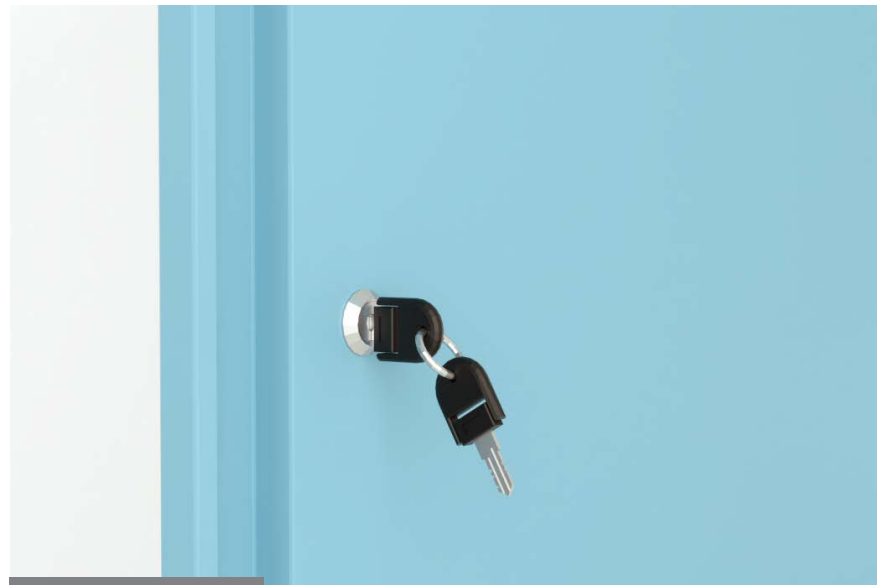

Detalhe fechadura



Prateleira

Porta Direita

Detalhe travamento

Prateleira para Armário Aço

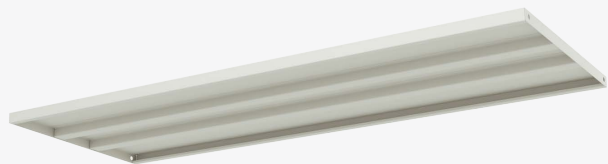
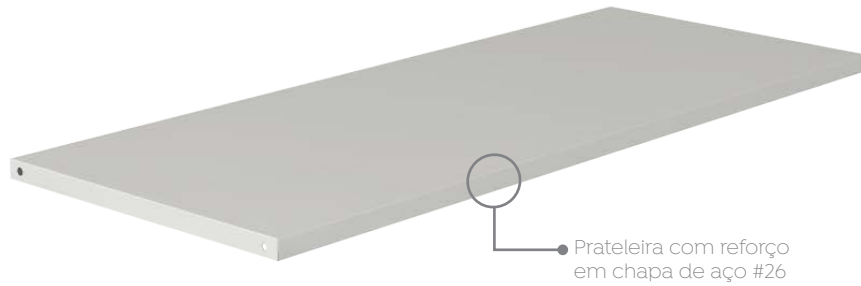

Fixação de Prateleiras



Chapa para fixação de prateleiras

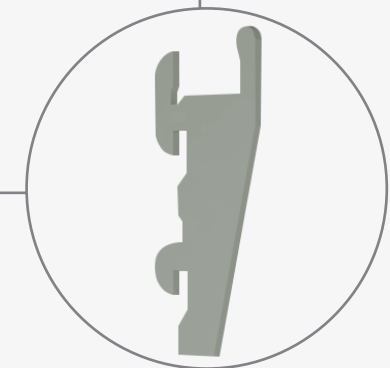

Prateleiras e Área útil interna e externa

Modelo do Armário	LI	LE	PI
Arm. Alto 1960A 800L 400P	799	700	359
Arm. Alto 1960A 900L 400P	899	800	359
Arm. Alto 1960A 1000L 400P	999	900	359
Arm. Alto 1960A 1100L 400P	1099	1000	359
Arm. Alto 1960A 1200L 400P	1199	1100	359

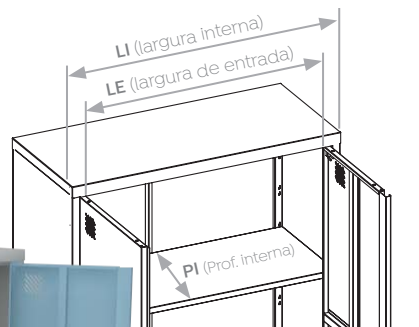

Arm. Alto - 4 prateleiras

Modelo do Armário	LI	LE	PI
Arm. Médio 1620A 750L 400P	749	650	359

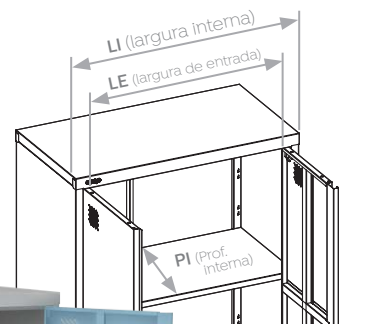

Arm. Médio - 3 prateleiras

Modelo do Armário	LI	LE	PI
Arm. Baixo 840A 800L 400P	799	700	359

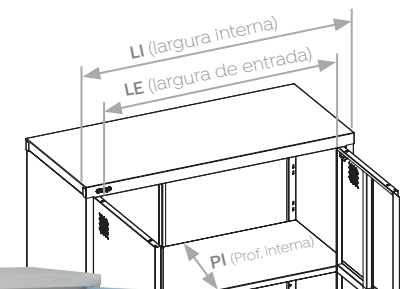

Arm. Baixo - 1 prateleira





Arquivos

Sumário (selecione o item) 

Arquivo Gaveta Patins.....	11
Arquivo Gaveta Patins / Modelos	11
Arquivo Gaveta Corr. Telescópica.....	12
Arquivo Aço 2 Gav Corr. Telesc.....	12

Arquivo Aço Gaveta Patins

Deslizamento por patins de nylon

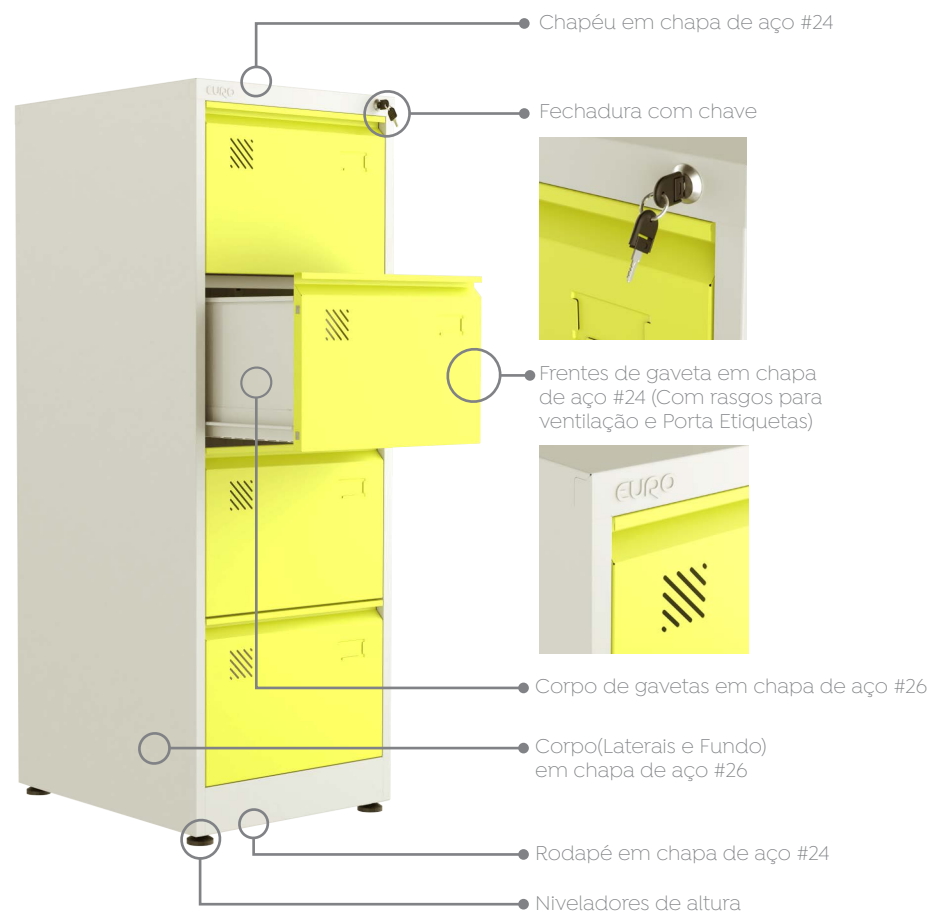

Modelos



Arquivo Aço
2 Gav Patins
Mod.: [ARQ02L](#)



Arquivo Aço
3 Gav Patins
Mod.: [ARQ03L](#)



Arquivo Aço
4 Gav Patins
Mod.: [ARQ04L](#)

Gaveta Patins

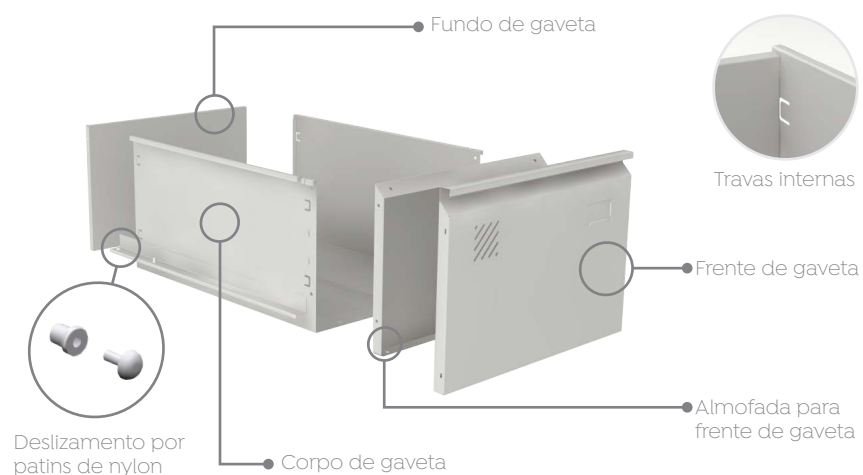

Arquivo Aço Gaveta Corrediça Telescópica

Deslizamento por corrediça telescópica

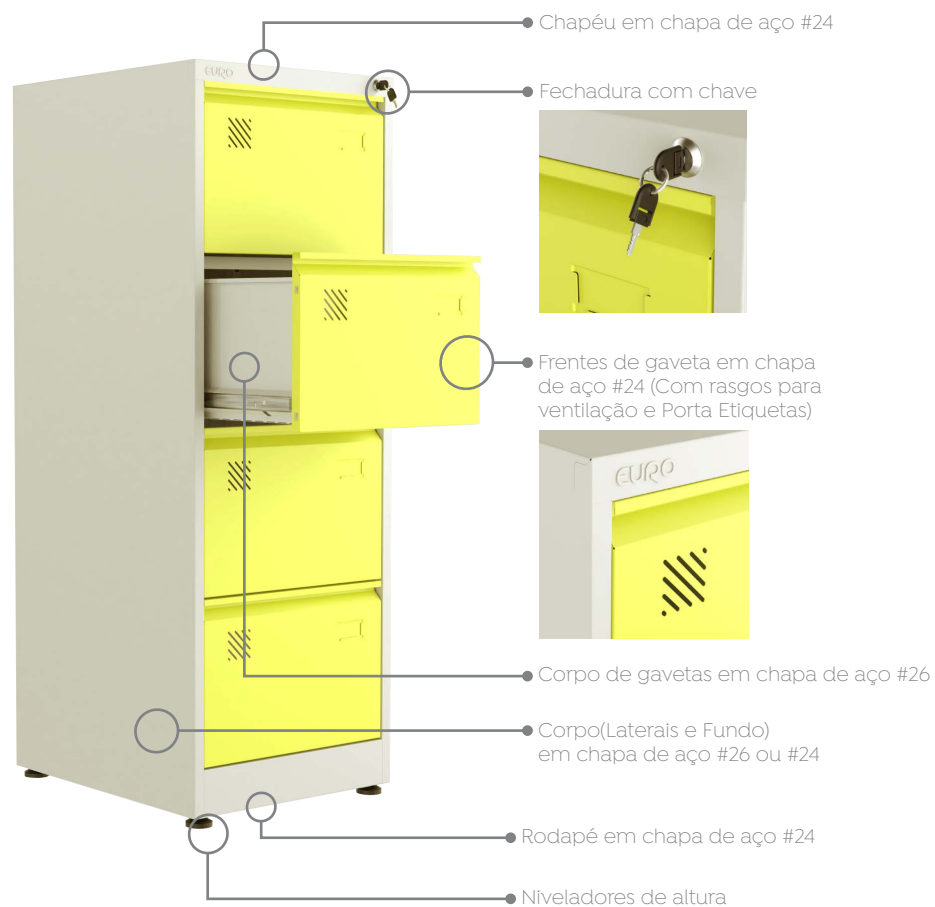

Modelos



Arquivo Aço
2 Gav Corr. Telescópica
Mod.: ARQ02LTC

Arquivo Aço
3 Gav Corr. Telescópica
Mod.: ARQ03LTC

Arquivo Aço 4 Gav
Corr. Telescópica 570P
Mod.: ARQ04LTC

Arquivo Aço 4 Gav
Corr. Telescópica 670P
Chapa #26:
Mod.: ARQ04LGT26
Chapa #24:
Mod.: ARQ04LGT24

Gaveta Corrediça Telescópica

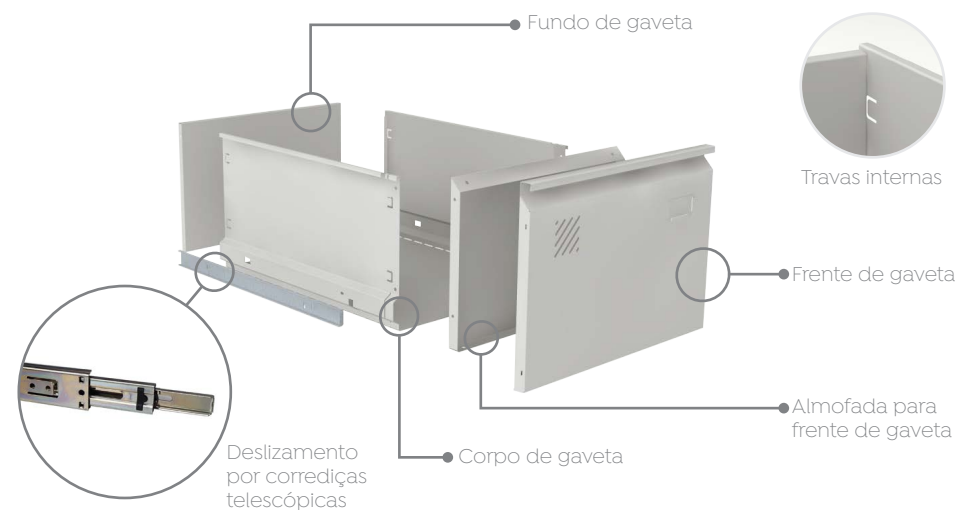



Área útil interna das gavetas

Gaveta Patins

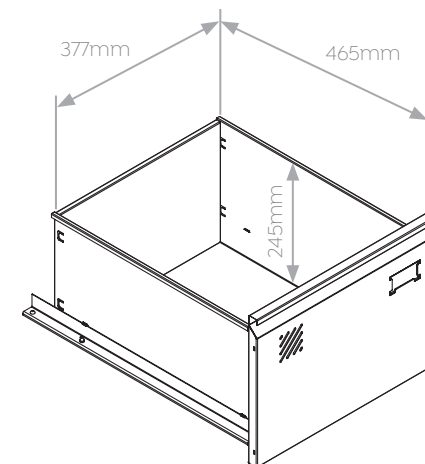

Gaveta Corrediça Telescópica

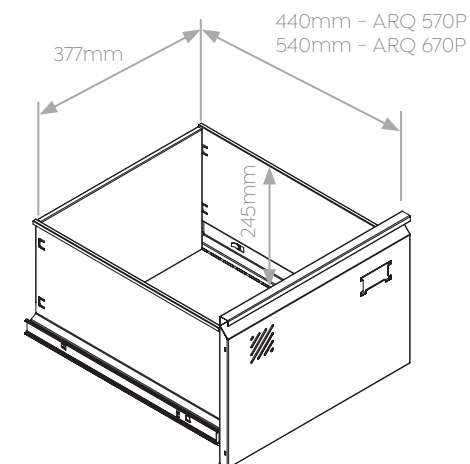





Lockers

Sumário (selecione o item)



Lockers Digilock.....	17
Locker Tradicional Digilock Tranca Tripla	17
Locker Insalubre Digilock Tranca Tripla	18
Lockers Fechadura Segredo	19
Locker Tradicional Fechadura Segredo Tranca Tripla	19
Locker Insalubre Fechadura Segredo Tranca Tripla	20
Lockers EasyLock.....	21
Locker EasyLock.....	21
Locker Insalubre EasyLock	22
Locker Porta Objeto EasyLock.....	23
Locker Caixa Postal EasyLock.....	24
Mini Locker EasyLock.....	25

Lockers Fechadura	26
Locker Fechadura Tranca Tripla	26
Locker Insalubre Fechadura Tranca Tripla	27
Locker Porta Objeto Fechadura.....	28
Locker Caixa Postal Fechadura.....	29
Mini Locker Fechadura com Tranca Tripla	30
Lockers Pitão	31
Locker Pitão Tranca Tripla	31
Locker Insalubre Pitão Tranca Tripla	32
Locker Porta Objeto Pitão.....	33
Locker Caixa Postal Pitão.....	34
Mini Locker Pitão Tranca Tripla	35



Locker Digilock Tranca Tripla



Modelos

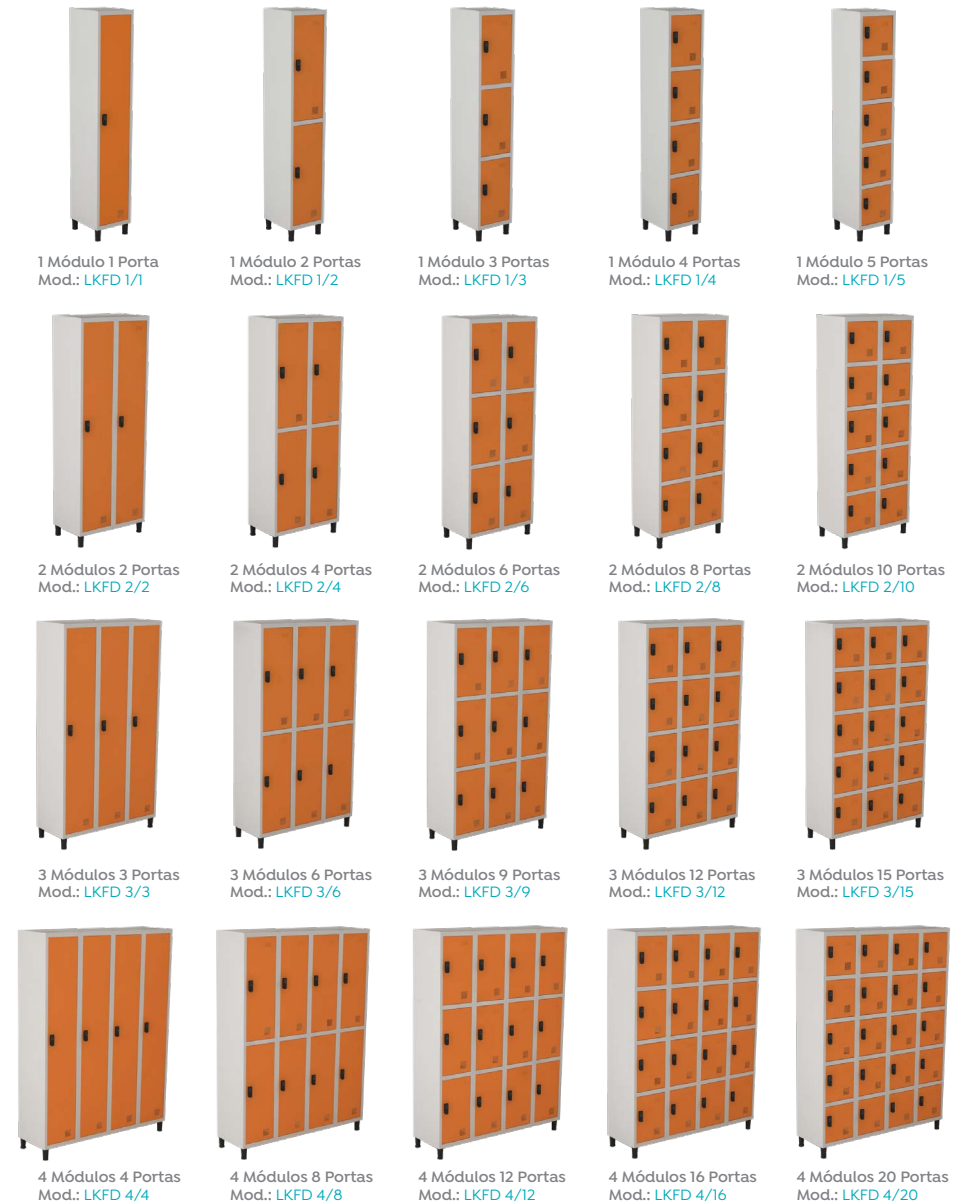

Locker Insalubre Digilock Tranca Tripla



Modelos



1 Módulo 2 Portas - **Divisória em T**
Mod.: LKINSTFD 1/2

1 Módulo 2 Portas - **Divisória Vertical**
Mod.: LKINSFD 1/2



2 Módulos 4 Portas - **Divisória em T**
Mod.: LKINSTFD 2/4

2 Módulos 4 Portas - **Divisória Vertical**
Mod.: LKINSFD 2/4



3 Módulos 6 Portas - **Divisória em T**
Mod.: LKINSTFD 3/6

3 Módulos 6 Portas - **Divisória Vertical**
Mod.: LKINSFD 3/6



Divisória em T



Divisória Vertical

Locker Fechadura Segredo Tranca Tripla



Modelos

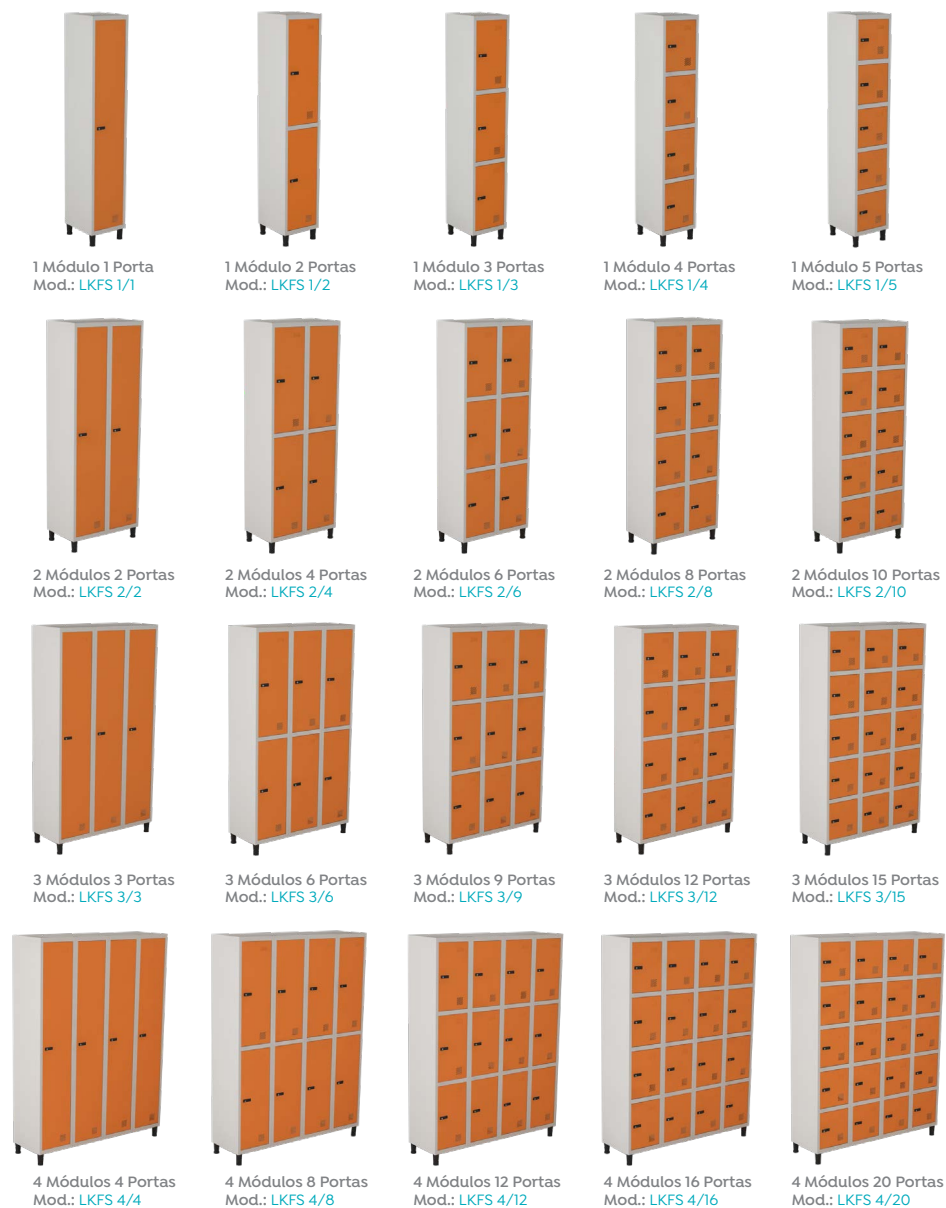

Locker Insalubre Fechadura Segredo Tranca Tripla



Modelos



1 Módulo 2 Portas - **Divisória em T**
Mod.: LKINSTFS 1/2

1 Módulo 2 Portas - **Divisória Vertical**
Mod.: LKINSFS 1/2



2 Módulos 4 Portas - **Divisória em T**
Mod.: LKINSTFS 2/4

2 Módulos 4 Portas - **Divisória Vertical**
Mod.: LKINSFS 2/4



3 Módulos 6 Portas - **Divisória em T**
Mod.: LKINSTFS 3/6

3 Módulos 6 Portas - **Divisória Vertical**
Mod.: LKINSFS 3/6



Divisória em T



Divisória Vertical

Locker EasyLock



Sistema EasyLock
clique para detalhes

Modelos

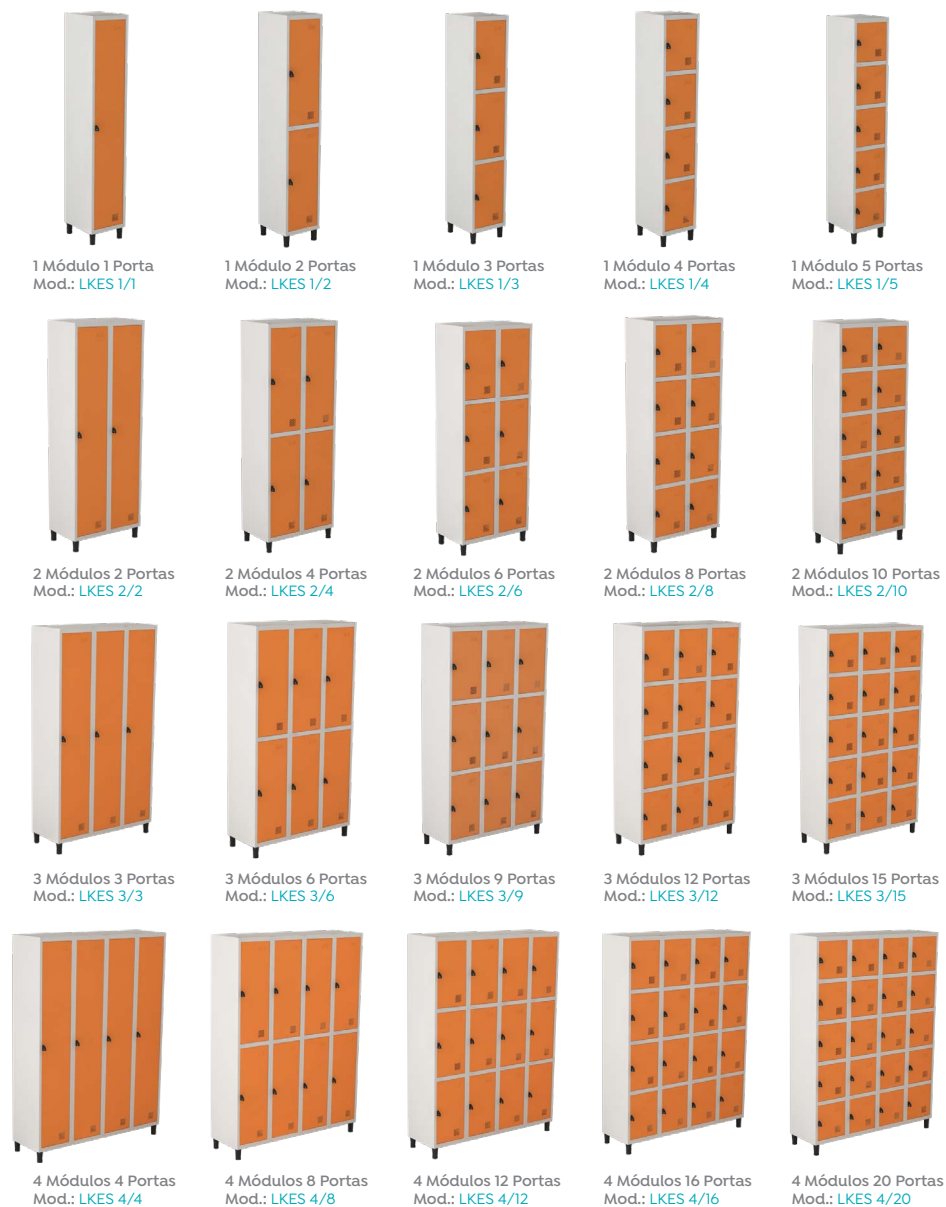

Locker Insalubre EasyLock



Modelos



1 Módulo 2 Portas - **Divisória em T**
Mod.: LKINSTES 1/2

1 Módulo 2 Portas - **Divisória Vertical**
Mod.: LKINSES 1/2



2 Módulos 4 Portas - **Divisória em T**
Mod.: LKINSTES 2/4

2 Módulos 4 Portas - **Divisória Vertical**
Mod.: LKINSES 2/4



3 Módulos 6 Portas - **Divisória em T**
Mod.: LKINSTES 3/6

3 Módulos 6 Portas - **Divisória Vertical**
Mod.: LKINSES 3/6



Divisória em T



Divisória Vertical

Locker Porta Objeto EasyLock

Modelos



1 Módulo 10 Portas
Mod.: LKPOES 1/10



2 Módulos 20 Portas
Mod.: LKPOES 2/20



3 Módulos 30 Portas
Mod.: LKPOES 3/30

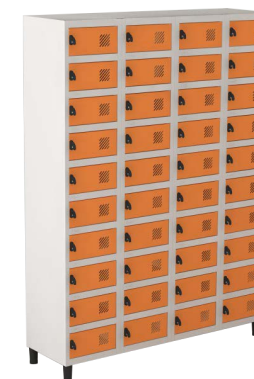

4 Módulos 40 Portas
Mod.: LKPOES 4/40

Locker Caixa Postal EasyLock

Modelos



1 Módulo 10 Portas
Mod.: LKCPES 1/10



2 Módulos 20 Portas
Mod.: LKCPES 2/20



3 Módulos 30 Portas
Mod.: LKCPES 3/30



4 Módulos 40 Portas
Mod.: LKCPES 4/40

Mini Locker EasyLock



Sistema EasyLock
 clique para detalhes

Modelos



1 Módulo 3 Portas
 Mod.: MLKES 1/3

Locker Fechadura Tranca Tripla



Modelos

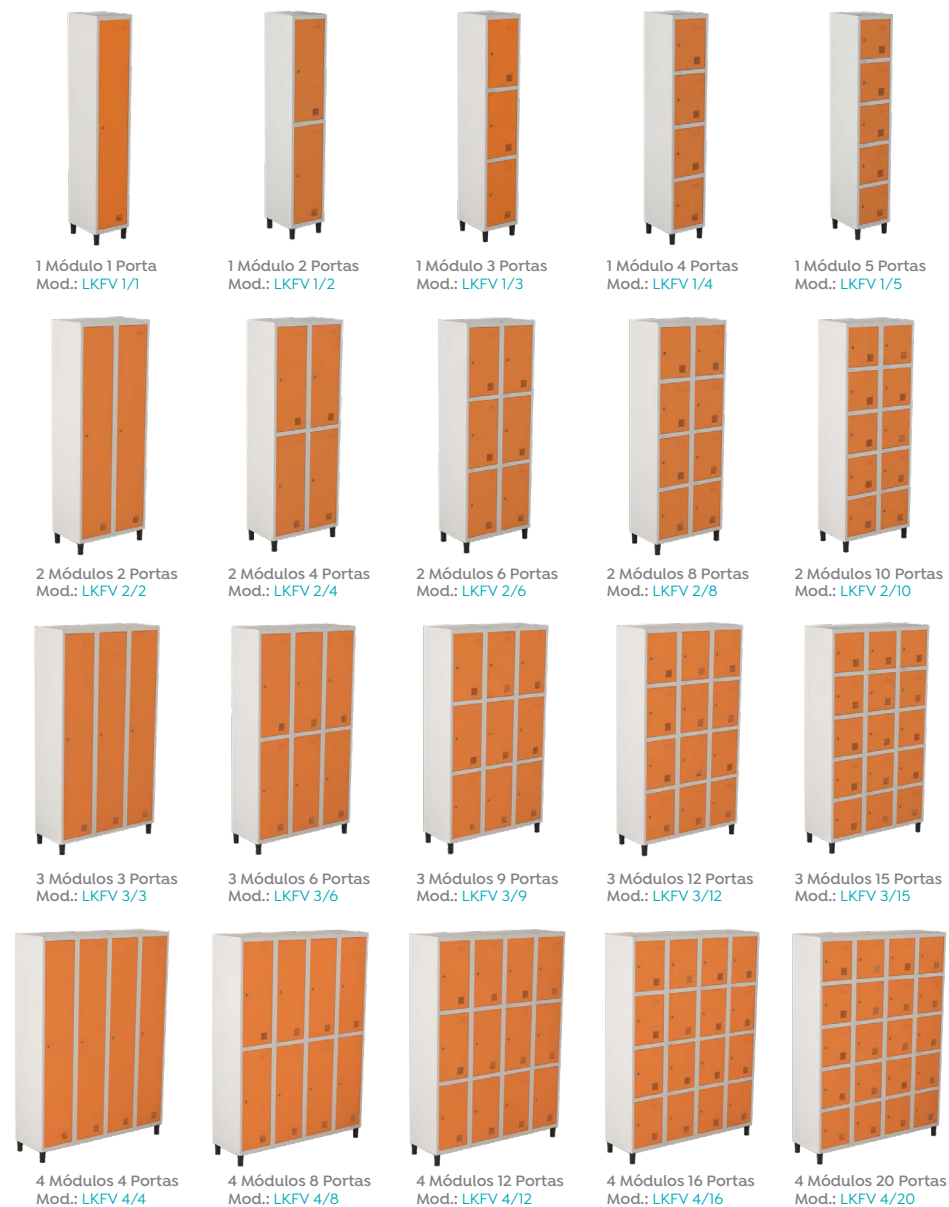

Locker Insalubre Fechadura Tranca Tripla



Modelos



1 Módulo 2 Portas - **Divisória em T**
Mod.: LKINSTFV 1/2

1 Módulo 2 Portas - **Divisória Vertical**
Mod.: LKINSFV 1/2



2 Módulos 4 Portas - **Divisória em T**
Mod.: LKINSTFV 2/4

2 Módulos 4 Portas - **Divisória Vertical**
Mod.: LKINSFV 2/4



3 Módulos 6 Portas - **Divisória em T**
Mod.: LKINSTFV 3/6

3 Módulos 6 Portas - **Divisória Vertical**
Mod.: LKINSFV 3/6



Divisória em T



Divisória Vertical

Locker Porta Objeto Fechadura

Modelos



1 Módulo 10 Portas
Mod.: LKPOF 1/10



2 Módulos 20 Portas
Mod.: LKPOF 2/20

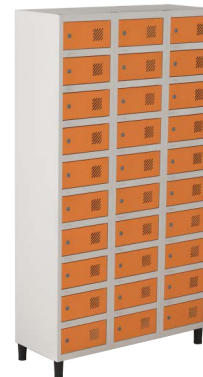

3 Módulos 30 Portas
Mod.: LKPOF 3/30

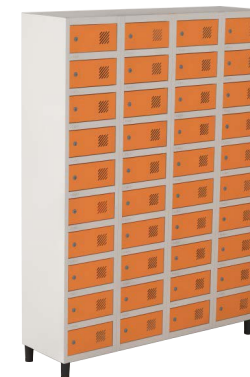

4 Módulos 40 Portas
Mod.: LKPOF 4/40

Locker Caixa Postal Fechadura

Modelos



1 Módulo 10 Portas
Mod.: LKPOF 1/10



2 Módulos 20 Portas
Mod.: LKPOF 2/20



3 Módulos 30 Portas
Mod.: LKPOF 3/30



4 Módulos 40 Portas
Mod.: LKPOF 4/40

Mini Locker Fechadura Tranca Tripla



Modelos



1 Módulo 3 Portas
Mod.: MLKFV 1/3

Locker Pitão Tranca Tripla



Modelos

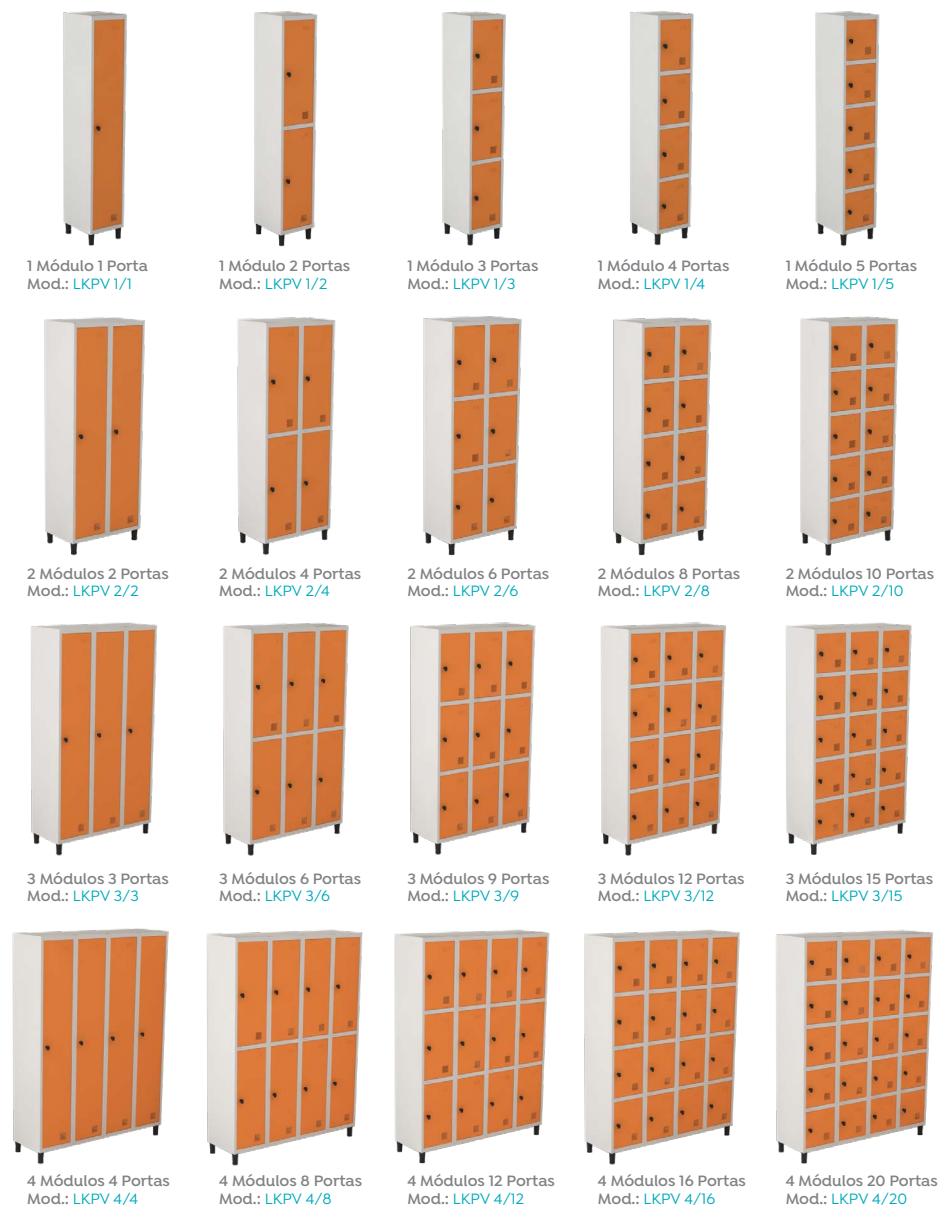

Locker Insalubre Pitão Tranca Tripla



Modelos



1 Módulo 2 Portas - **Divisória em T**
Mod.: LKINSTPV 1/2

1 Módulo 2 Portas - **Divisória Vertical**
Mod.: LKINSPV 1/2



2 Módulos 4 Portas - **Divisória em T**
Mod.: LKINSTPV 2/4

2 Módulos 4 Portas - **Divisória Vertical**
Mod.: LKINSPV 2/4



3 Módulos 6 Portas - **Divisória em T**
Mod.: LKINSTPV 3/6

3 Módulos 6 Portas - **Divisória Vertical**
Mod.: LKINSPV 3/6



Divisória em T



Divisória Vertical

Locker Porta Objeto Pitão

Modelos



1 Módulo 10 Portas
Mod.: LKPOP 1/10



2 Módulos 20 Portas
Mod.: LKPOP 2/20



3 Módulos 30 Portas
Mod.: LKPOP 3/30

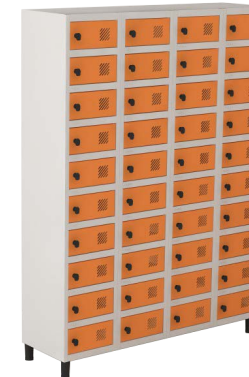

4 Módulos 40 Portas
Mod.: LKPOP 4/40

Locker Caixa Postal Pitão

Modelos



1 Módulo 10 Portas
Mod.: LKCPP 1/10



2 Módulos 20 Portas
Mod.: LKCPP 2/20



3 Módulos 30 Portas
Mod.: LKCPP 3/30



4 Módulos 40 Portas
Mod.: LKCPP 4/40

Mini Locker Pitão Tranca Tripla



Modelos



1 Módulo 3 Portas
Mod.: MLKPV 1/3

Medidas dos vãos das portas e profundidade

Locker Padrão



Módulo 1 porta

Módulo 2 portas

Módulo 3 portas

Módulo 4 portas

Módulo 5 portas

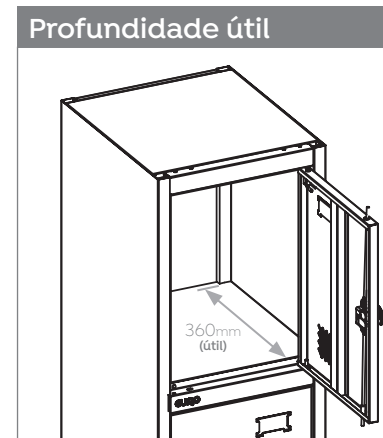

Medidas dos vãos das portas e profundidade

Locker Insalubre



2 Portas Divisão T

2 Portas Divisão Vertical

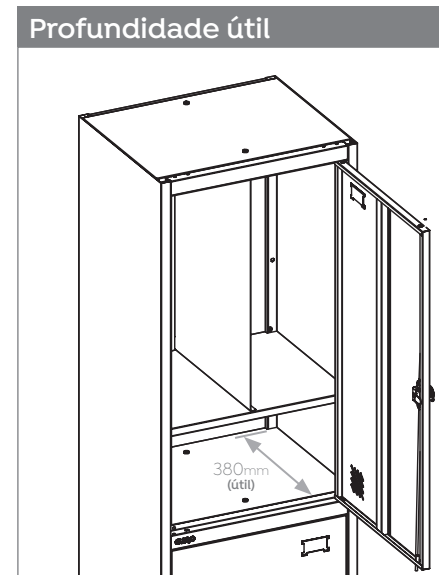

Medidas dos vãos das portas e profundidade

Mini Locker



Profundidade útil

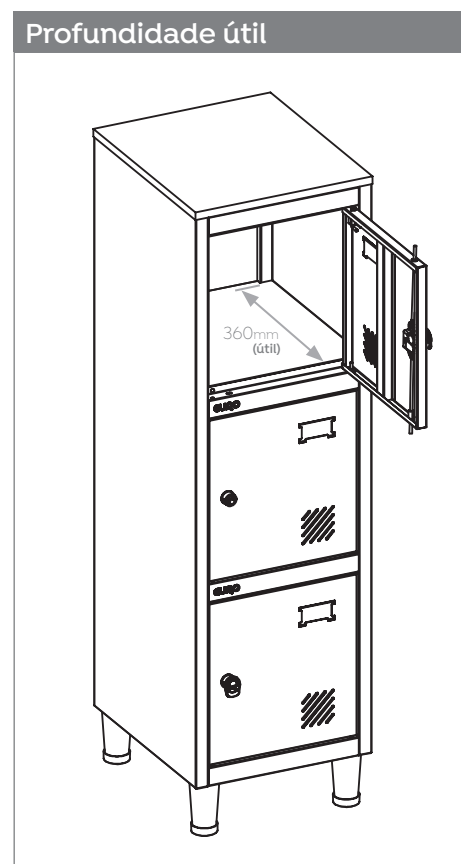

Montagem dos Módulos (Acoplamento)

- Todos os modelos seguem o mesmo sistema para acréscimo de módulos.



Sistema de montagem - Acoplamento de módulos

1. Retire as portas e solte a lateral Direita do Módulo Lateral.

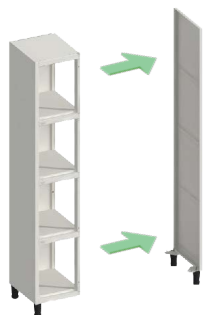

2. Acrescente o Módulo Central

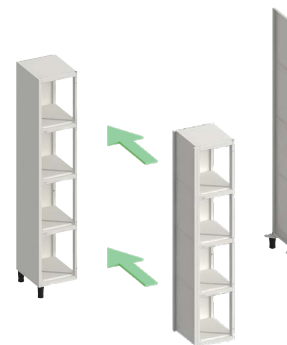

3. Com o Módulo Central devidamente fixado, faça o fechamento com a lateral que foi solta no 1º passo.

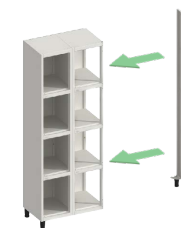

Obs: Se for necessário inserir mais módulos, antes de fazer o fechamento deve-se repetir o 2º passo até atingir a quantidade de lugares desejada.

4. Faça a fixação dos parafusos



Obs: Se for necessário inserir mais módulos, antes de fazer o fechamento deve-se repetir o 2º passo até atingir a quantidade de lugares desejada.

5. Recoloque as portas



6. Locker montado







Estantes

Sumário (selecione o item)

Estantes de Aço	42
Estante de Aço linha FIT sem reforço.....	42
Estante de Aço linha FIT com reforço.....	43
Estante de Aço padrão sem reforço	44
Estante de Aço padrão com reforço	45
Colunas para Estante de Aço	46
Coluna furo oblongo.....	46
Coluna Industrial L2.....	46
Coluna Industrial L3.....	46
Coluna Industrial L5.....	46
Prateleiras para Estante de Aço.....	47
Prateleira com reforço - Conjunto de 3 prateleiras.....	47
Prateleira com reforço - Conjunto de 5 prateleiras.....	47
Prateleira com reforço - Conjunto de 6 prateleiras.....	47
Reforço em X para Estante de Aço	48
Reforço Lateral em X.....	48
Reforço Fundo em X.....	48
Painéis de Fechamento para Estante de Aço.....	49
Painel de Fechamento Lateral.....	49
Painel de Fechamento Fundo.....	49

Estante de Aço linha FIT sem reforço



Modelos



Estante 3 Prateleiras Canto
910A 400L 300P 20/26
Mod.: EMSR3FITC



Estante 3 Prateleiras
910A 920L 270P 20/26
Mod.: EMSR3FIT



Estante 5 Prateleiras
1765A 920L 270P 20/26
Mod.: EMSR5FIT



Estante 6 Prateleiras
1765A 920L 270P 20/26
Mod.: EMSR6FIT

Estante de Aço linha FIT com reforço



Modelos



Estante 3 Prateleiras
910A 920L 300P 20/26
Mod.: EMCR3FIT



Estante 5 Prateleiras
1765A 920L 300P 20/26
Mod.: EMCR5FIT



Estante 6 Prateleiras
1765A 920L 300P 20/26
Mod.: EMCR6FIT

Estante de Aço Padrão sem reforço



Modelos



Estante 5 Prateleiras
1800A 920L 300P 20/26
Mod.: EMSR5A



Estante 6 Prateleiras
2000A 920L 300P 20/26
Mod.: EMSR6A

Estante de Aço Padrão com reforço



Modelos



Estante 5 Prateleiras
1800A 920L 300P 20/26
Mod.: [EMCR5AR](#)



Estante 6 Prateleiras
2000A 920L 300P 20/26
Mod.: [EMCR6AR](#)

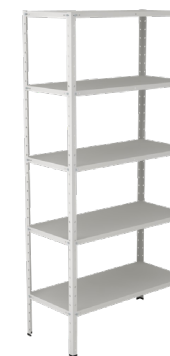

Estante 5 Prateleiras
1800A 920L 400P 20/26
Mod.: [EMCR5BR](#)



Estante 6 Prateleiras
2000A 920L 400P 20/26
Mod.: [EMCR6BR](#)



Estante 6 Prateleiras
2000A 920L 300P 18/24
Mod.: [EMCR6AE](#)



Estante 6 Prateleiras
2000A 920L 400P 18/24
Mod.: [EMCR6BE](#)

Colunas para Estante de Aço

Colunas L furo Oblongo



Colunas L Industrial

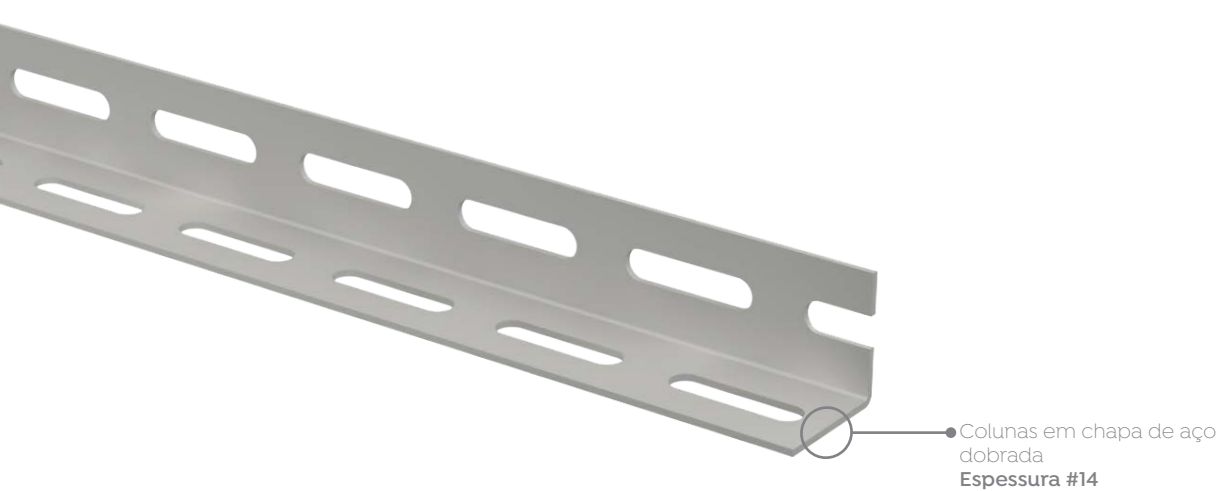

Modelos



Coluna Furo Oblongo
Conjunto 4 colunas



Coluna Industrial L2
Conjunto 4 colunas



Coluna Industrial L3
Conjunto 4 colunas



Coluna Industrial L5
Conjunto 4 colunas

Prateleiras para Estante de Aço

Modelos

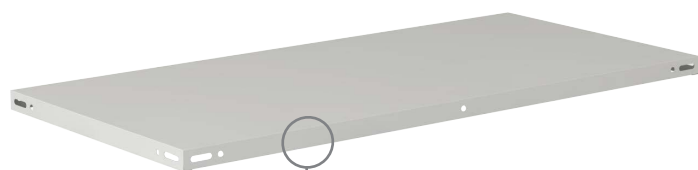

● Prateleiras em chapa de aço dobrada com reforço
Espessuras: #26, #24, #22, #20 e #16



● Prateleiras com 300 e 400mm de profundidade possuem reforço único



● Prateleiras com 580mm de profundidade possuem reforço duplo



Prateleira com Reforço
Conjunto com 3 prateleiras



Prateleira com Reforço
Conjunto com 5 prateleiras



Prateleira com Reforço
Conjunto com 6 prateleiras

Reforço em X para Estante de Aço

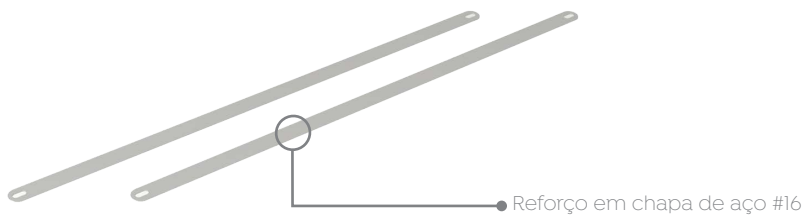
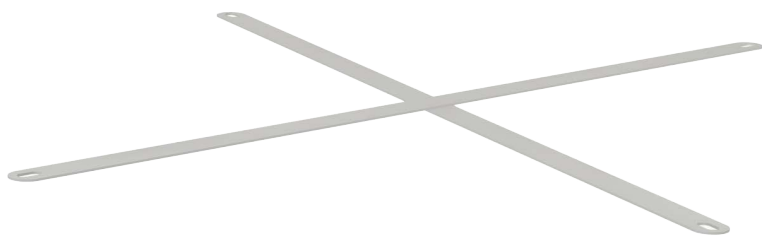

Modelos



Reforço Lateral em X
Conjunto com 4 jogos de X

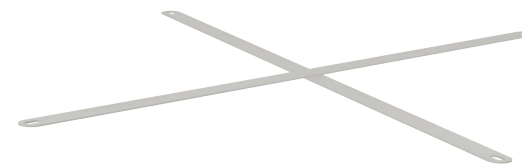

Reforço Fundo em X
(Individual)

Painéis de Fechamento para Estante de Aço

(para laterais e fundo)



● Painéis de Fechamento, peça única
(Para estantes de até 2000mm de altura)
em chapa de aço #26



● Painéis de Fechamento +
complemento (Para estantes
acima 2000mm de altura)
em chapa de aço #26

Modelos



Painel de Fechamento Lateral
para estante até 2000A
Conjunto 2 Painéis
(Fechamento p/ os dois
lados da estante)



**Painel de Fechamento Lateral +
Complemento para estante acima
de 2000A**
Conjunto 2 Painéis
(Fechamento p/ os dois
lados da estante)



Painel de Fechamento Fundo
para estante até 2000A
Conjunto 2 Painéis
(Individual)



**Painel de Fechamento Fundo +
Complemento para estante acima
de 2000A**
Conjunto 2 Painéis
(Individual)



www.marzovitorino.com.br

EURO

MÓVEIS
DE AÇO

marzo vitorino